

## WIRELESS POWER CHARGING COIL

- ◆ Qi-standard compliant
- ◆ Evaluated and approved by every major semiconductor manufacturer
- ◆ LZ wire used-highest Q-value available on market
- ◆ High permeability shielding
- ◆ High reliable construction
- ◆ Applicable for up 20W
- ◆ Cancels charging flux to be not coupled into sensitive components or batteries



### ELECTRICAL SPECIFICATIONS@25°C,33%RH (Operating Temperature:-25°C to 105°C)

Part Number	Ls @100KHz,1V,0A <sub>dc</sub>	DCR	HI-POT @VAC/2mA/2Sec
	S-F	S-F	Winding to Core
PW26042DL	8.0uH±10%	520mΩ±20%	750

### MECHANICAL (Unit: mm)

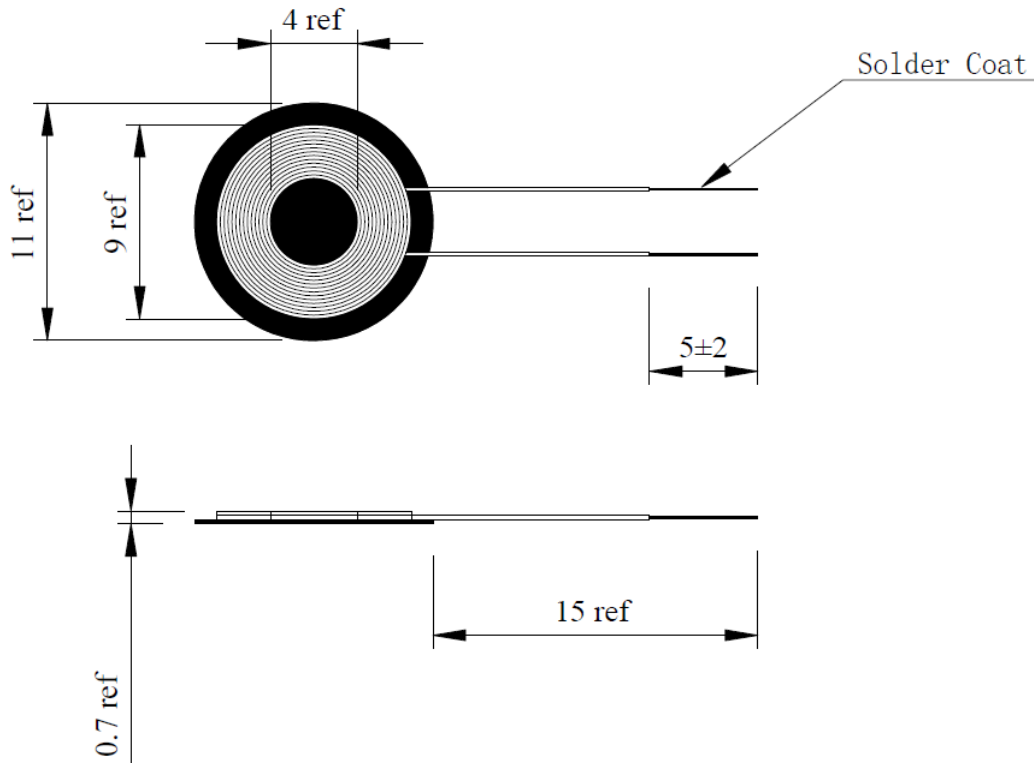

### SCHEMATICS

