



MC0650 series

Features:

- Large Current and Low DCR.
- Magnetically shielded construction.
- High frequency range up to 1.0 MHz.
- RoHS compliant* and halogen free.
- Low noise.
- Operating temperature range: -40°C TO +125°C

Applications:

- Notebooks/Desktops/Server applications.
- Low profile, high current power supplies.
- Battery powered devices.
- DC/DC converters.

Product identification:

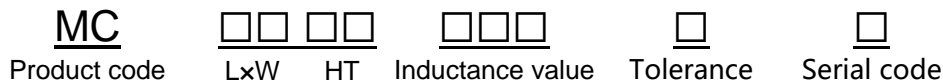

Dimensions (unit:inch/ mm):

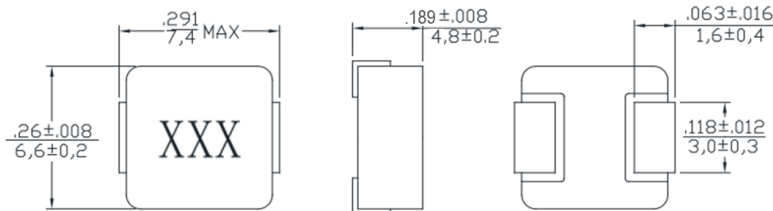

Recommended Layout: [unit: inch/ mm]

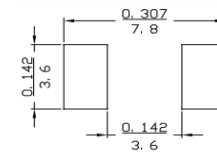

Electrical Specifications @ 25°C

P/N	100KHz 0.25V	D.C.R (mΩ)		Heat Rating Current	Saturation Current
	L0(μH) ±20% '@0A	Typical	Max	Idc (Amp) Typical	Isat (Amp) Typical
MC0650-R22M1	0.22	1.8	2.5	18	32
MC0650-R47M1	0.47	2.8	3.8	15	22
MC0650-1R0M1	1	5.6	7	12	13
MC0650-1R5M1	1.5	7.1	8.5	10	12
MC0650-2R2M1	2.2	11.6	13.5	7	10
MC0650-3R3M1	3.3	19.6	22	6.5	9
MC0650-4R7M1	4.7	27	30	5.7	8
MC0650-6R8M1	6.8	38	44	5	7
MC0650-100M1	10	46	55	4.2	6
MC0650-150M1	15	72	85	3.5	4
MC0650-220M1	22	105	120	2.8	3.2
MC0650-330M1	33	158	180	2.4	3
MC0650-470M1	47	240	270	2	2.5
MC0650-680M1	68	360	400	1.4	2
MC0650-101M1	100	455	500	1	1.6

- Note:
- All test date is referenced to 25°C ambient.
 - DC current(Idc) that will cause an approximate ΔT of 40°C.
 - DC current(last) that will cause Lo to drop approximately 30%.
 - Operating temperature range:-40°C to +125°C.
 - The part temperature (ambient + temp rise) should not exceed125°C under the worst operating conditions. Circuit design, component placement, PWB trace size and thickness, airflow and other cooling provisions all affect the part temperature. Part temperature should be verified in the end application.

Packaging

1) Reel dimensions

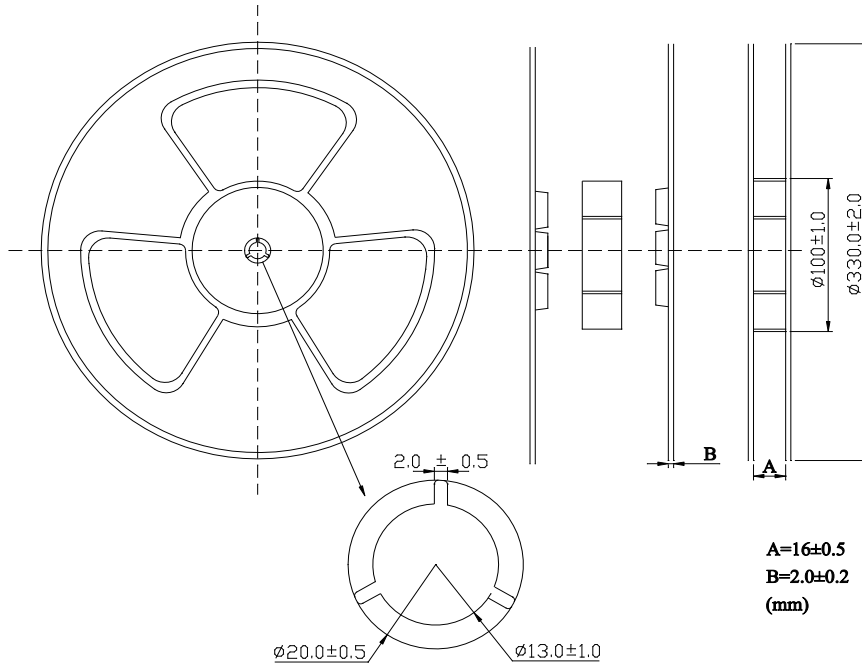

2) Tape packaging dimensions

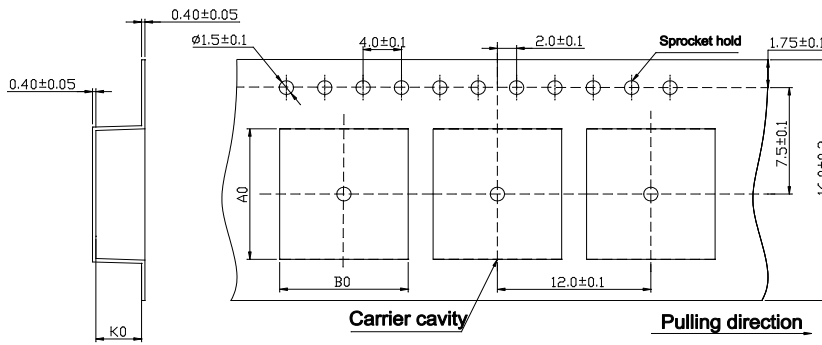

Dimensions Code (mm)		
A0	B0	K0
7.0±0.05	8.0±0.05	5.0±0.1

3) Tape Direction

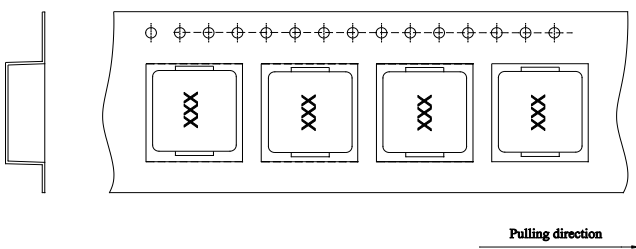

4) Peel force of top cover tape

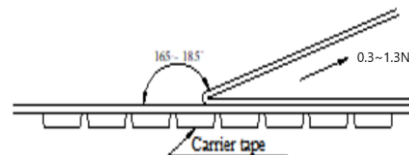

The peel speed shall be about 300 mm/minute
 The peel force of top cover tape shall be between 0.3 to 1.3N

Numbers of packaging: 1000 pieces / reel.

Reminders

Please pay sufficient attention to the warnings for safe designing when using these products.

- ※ The storage period is less than 12 months. Be sure to follow the storage conditions (Temperature: 5 to 40°C, Humidity: 10 to 75% RH or less).
If the storage period elapses, the soldering of the terminal electrodes may deteriorate.
- ※ Do not use or store in locations where there are conditions such as gas corrosion (salt, acid, alkali, etc.).
- ※ Before soldering, be sure to preheat components.
The preheating temperature should be set so that the temperature difference between the solder temperature and chip temperature does not exceed 150°C.
- ※ Soldering corrections after mounting should be within the range of the conditions determined in the specifications.
If overheated, a short circuit, performance deterioration, or lifespan shortening may occur.
- ※ Self heating (temperature increase) occurs when the power is turned ON, so the tolerance should be sufficient for the set thermal design.
- ※ Do not expose the products to magnets or magnetic fields.
Do not use for a purpose outside of the contents regulated in the delivery specifications.